



**WEAVER GENERAL CONSTRUCTION COMPANY**  
 3679 S. Huron St., Suite 404  
 Englewood, CO 80110  
 Phone: (303) 789-4111 FAX: (303) 789-4310

**SUBMITTAL TRANSMITTAL**

November 2, 2011  
WGC Submittal No: 03300-023.A

**PROJECT:** Harold Thompson Regional WRF  
 Birdsall Rd.  
 Fountain, CO 80817  
 Job No. 2908

**ENGINEER:** GMS, Inc.  
 611 No. Weber St., #300  
 Colorado Springs, CO 80903  
 719-475-2935 Roger Sams

**OWNER:** Lower Fountain Metropolitan  
 Sewage Disposal District  
 901 S. Santa Fe Ave.  
 Fountain, CO 80817  
 719-382-5303 James Heckman

**CONTRACTOR:** Baker Concrete Construction  
 1904 Jasper Street  
 Aurora, CO 80011  
 937-536-9000 Nick Dewald

**SUBJECT:** Resubmittal - Request to use previously approved submittal materials at the Pumping & Disinfectant Building

*BCCI Remarks: "BCCI proposes to use the same approved material from the Aeration Basin, Digester and the Headworks Bldg in the Pumping and Disinfectant Building."*

**SPEC SECTION:** 03300: Cast-In-Place

**PREVIOUS SUBMISSION DATES:** 10/25/11

**DEVIATIONS FROM SPEC:** \_\_\_ YES X NO

**CONTRACTOR'S STAMP:** This submittal has been reviewed by Weaver General Construction and approved with respect to the means, methods, techniques, & safety precautions & programs incidental thereto. Weaver General Construction also warrants that this submittal complies with contracted documents and comprises on deviations thereto:

**Contractor's Stamp:**

Date: 11/02/11  
 Reviewed by: H.C. Myers  
 ( X ) Reviewed Without Comments  
 ( ) Reviewed With Comments

**ENGINEER'S COMMENTS:**

**Engineer's Stamp:**



**GMS, INC.**  
CONSULTING ENGINEERS  
611 NORTH WEBER, SUITE 300  
COLORADO SPRINGS, COLORADO 80903-1074

TELEPHONE (719) 475-2935  
TELEFAX (719) 475-2938

EDWARD D. MEYER, P.E.  
ROGER J. SAMS, P.E.  
GREGORY R. WORDEN, P.E.  
THOMAS A. McCLERNAN, P.E.

KEN L. WHITE, P.L.S.  
DAVID R. FRISCH, P.L.S.  
MARK A. MORTON, P.E.  
JASON D. MEYER, P.E.

October 25, 2011

Mr. Wes Weaver, President  
Weaver Construction Management, Inc.  
3679 South Huron Street, Suite 404  
Englewood, CO 80110

*Via Email to: wes@weavergc.com  
No Hard Copy to Follow*

Re: Harold D. Thompson Regional Water Reclamation Facility (HDTRWRF)  
Lower Fountain Metropolitan Sewage Disposal District (LFMSDD)

Dear Wes:

Reference is made to your shop submittal identified as follows:

Submittal No.:	03300-023
Date of Submittal:	October 25, 2011
Title:	Pumping and Disinfection Building Submittal Letter
Specification Section:	03300
Supplier:	Baker Concrete Construction

The referenced submittal has been stamped "**Revise and Resubmit**". Our comments are as follows:

1. A submittal letter stating the materials to be used must include, at a minimum, the following:
  - a. Mix design number to be used
  - b. Reference to the shop submittal number and letter approving the mix design
2. Numerous submittals and resubmittals were received and comments made on mix designs for the aeration basins and digesters. In light of that, it is necessary to have the specific mix designs and submittal reference where that mix design was approved.

Please call if you should have any questions.

Sincerely,

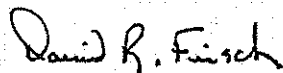

David R. Frisch, P.L.S.

DRF/kmw

ec (letter only):

Mr. Jim Heckman, Manager, LFMSDD, [lfmanager@lfmsdd.org](mailto:lfmanager@lfmsdd.org)  
Ms. Cindy Murray, Office Manager, Fountain Sanitation District, [fsdistrict@fsd901.org](mailto:fsdistrict@fsd901.org)  
Mr. Jeff Burst, Project Supt., Weaver Construction Management, Inc., [jeff@weavergc.com](mailto:jeff@weavergc.com)  
Mr. John Jacob, Project Mgr., Weaver Construction Management, Inc., [john@weavergc.com](mailto:john@weavergc.com)  
Mr. Tyler Ammerman, Weaver Construction Management, Inc., [tammerman@weavergc.com](mailto:tammerman@weavergc.com)  
Ms. Leslie Brown, Weaver Construction Management, Inc., [leslie@weavergc.com](mailto:leslie@weavergc.com)

cc: Mr. Jerry Miller, Resident Project Representative, GMS, Inc.



Tuesday November 01, 2011

Weaver Construction Company  
Attn: Mr. Wes Weaver  
3679 South Huron St.  
Englewood, CO 80110  
Phone: (303) 789-4111  
Fax: (303) 789-4310

**Re: Harold D. Thompson WRF Project, Fountain, CO**

**Subject: Pumping and Disinfectant Building Submittals**

Dear Wes,

Baker Concrete Construction, Inc. proposes to use the same approved material from the Aeration Basin, Digester and Headworks Building in the Pumping & Disinfectant building per the approved submittals listed below.

- Submittal # 03300-001, Form Release – Ezkote Green,
- Submittal # 03300-003, Cure – Maxcure Resin Clear
- Submittal # 03300-004, Waterstop – Greenstreak PVC Waterstop (*product # 735 and # 717*)
- Submittal # 03300-016, Waterstop – BoMetals PVC Waterstop (*RCB - 938NT*)
- Submittal # 03300-005, Expansion Joint – Fibre Expansion Joint Filler
- Submittal # 03300-008B, Patching Material – Verticote Supreme
- Submittal # 03300-009B, Concrete – Mix Design A65FDP for piers
- Submittal # 03300-009H, Concrete – Mix Design A70F, 5” slump for Walls, 3” Slump for slabs
- Submittal # 03600-002A, Injectable Grout – Green Mountain Grout
- WGC RFI 18A, Waterstop – Sika Swell S2

**If you have any questions, or if we can be of any further service, please call me at (303) 229-2695.**

Sincerely,

**BAKER CONCRETE CONSTRUCTION, INC.**

Nick Dewald  
Project Engineer  
Cc: Submittal 03300-023A

**GMS, INC.**  
CONSULTING ENGINEERS  
611 NORTH WEBER, SUITE 300  
COLORADO SPRINGS, COLORADO 80903-1074

OCT 11 2010

TELEPHONE (719) 475-2935  
TELEFAX (719) 475-2938

EDWARD D. MEYER, P.E.  
ROGER J. SAMS, P.E.  
GREGORY R. WORDEN, P.E.  
THOMAS A. McCLERNAN, P.E.

KEN L. WHITE, P.L.S.  
DAVID R. FRISCH, P.L.S.  
MARK A. MORTON, P.E.  
JASON D. MEYER, P.E.

October 7, 2010

Mr. Wes Weaver, President  
Weaver General Construction Co.  
3679 South Huron Street, Suite 404  
Englewood, CO 80110

*Via Email to: wes@weavergc.com  
No Hard Copy to Follow*

Re: Harold D. Thompson Regional Water Reclamation Facility (HDTRWRF)  
Lower Fountain Metropolitan Sewage Disposal District (LFMSDD)

Dear Wes:

Reference is made to your shop submittal identified as follows:

Submittal No.:	03300-001
Date of Submittal:	September 27, 2010
Title:	Ezkote Green Form Release
Specification Section:	03300
Manufacturer:	US Spec

The referenced submittal has been stamped "**No Exception Taken**". No additional information or resubmittal is required on this item.

Please call if you should have any questions.

Sincerely,

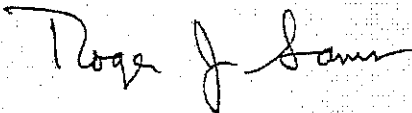

Roger J. Sams, P.E.

RJS/kmw

cc (letter only):

Mr. Jim Heckman, Manager, LFMSDD, [jfmanager@lfmsdd.org](mailto:jfmanager@lfmsdd.org)  
Mr. Jerry Miller, Resident Project Representative, GMS, Inc.  
Ms. Leslie Brown, Weaver General Construction Co., [leslie@weavergc.com](mailto:leslie@weavergc.com)

**GMS, INC.**  
CONSULTING ENGINEERS  
611 NORTH WEBER, SUITE 300  
COLORADO SPRINGS, COLORADO 80903-1074

TELEPHONE (719) 475-2935  
TELEFAX (719) 475-2938

EDWARD D. MEYER, P.E.  
ROGER J. SAMS, P.E.  
GREGORY R. WORDEN, P.E.  
THOMAS A. McCLERNAN, P.E.

KEN L. WHITE, P.L.S.  
DAVID R. FRISCH, P.L.S.  
MARK A. MORTON, P.E.  
JASON D. MEYER, P.E.

October 7, 2010

Mr. Wes Weaver, President  
Weaver General Construction Co.  
3679 South Huron Street, Suite 404  
Englewood, CO 80110

*Via Email to: wes@weavergc.com  
No Hard Copy to Follow*

Re: Harold D. Thompson Regional Water Reclamation Facility (HDTRWRF)  
Lower Fountain Metropolitan Sewage Disposal District (LFMSDD)

Dear Wes:

Reference is made to your shop submittal identified as follows:

Submittal No.:	03300-003
Date of Submittal:	September 27, 2010
Title:	Maxcure Resin Curing Compound
Specification Section:	03300
Manufacturer:	US Spec

The referenced submittal has been stamped "**No Exception Taken**". No additional information or resubmittal is required on this item.

Please call if you should have any questions.

Sincerely,

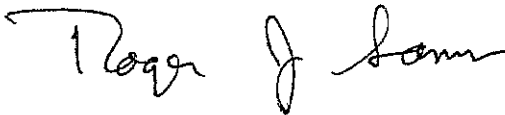

Roger J. Sams, P.E.

RJS/kmw

cc (letter only):

Mr. Jim Heckman, Manager, LFMSDD, [jfmanager@lfmsdd.org](mailto:jfmanager@lfmsdd.org)  
Mr. Jerry Miller, Resident Project Representative, GMS, Inc.  
Ms. Leslie Brown, Weaver General Construction Co., [leslie@weavergc.com](mailto:leslie@weavergc.com)

**GMS, INC.**  
CONSULTING ENGINEERS  
611 NORTH WEBER, SUITE 300  
COLORADO SPRINGS, COLORADO 80903-1074

OCT 14 2010

TELEPHONE (719) 475-2935  
TELEFAX (719) 475-2938

EDWARD D. MEYER, P.E.  
ROGER J. SAMS, P.E.  
GREGORY R. WORDEN, P.E.  
THOMAS A. McCLERNAN, P.E.

KEN L. WHITE, P.L.S.  
DAVID R. FRISCH, P.L.S.  
MARK A. MORTON, P.E.  
JASON D. MEYER, P.E.

October 7, 2010

Mr. Wes Weaver, President  
Weaver General Construction Co.  
3679 South Huron Street, Suite 404  
Englewood, CO 80110

*Via Email to: wes@weavergc.com  
No Hard Copy to Follow*

Re: Harold D. Thompson Regional Water Reclamation Facility (HDTRWRF)  
Lower Fountain Metropolitan Sewage Disposal District (LFMSDD)

Dear Wes:

Reference is made to your shop submittal identified as follows:

Submittal No.:	03300-004
Date of Submittal:	September 27, 2010
Title:	Waterstop
Specification Section:	03300
Manufacturer:	Greenstreak Group, Inc.

The referenced submittal has been stamped "**No Exception Taken**". No additional information or resubmittal is required on this item.

Please call if you should have any questions.

Sincerely,

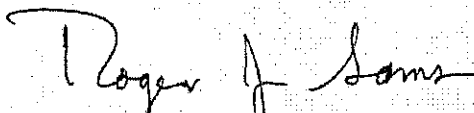

Roger J. Sams, P.E.

RJS/kmw

cc (letter only):

Mr. Jim Heckman, Manager, LFMSDD, [jfmanager@lfmsdd.org](mailto:jfmanager@lfmsdd.org)  
Mr. Jerry Miller, Resident Project Representative, GMS, Inc.  
Ms. Leslie Brown, Weaver General Construction Co., [leslie@weavergc.com](mailto:leslie@weavergc.com)

**GMS, INC.**  
CONSULTING ENGINEERS  
611 NORTH WEBER, SUITE 300  
COLORADO SPRINGS, COLORADO 80903-1074

OCT 11 2010

TELEPHONE (719) 475-2935  
TELEFAX (719) 475-2938

EDWARD D. MEYER, P.E.  
ROGER J. SAMS, P.E.  
GREGORY R. WORDEN, P.E.  
THOMAS A. McCLERNAN, P.E.

KEN L. WHITE, P.L.S.  
DAVID R. FRISCH, P.L.S.  
MARK A. MORTON, P.E.  
JASON D. MEYER, P.E.

October 7, 2010

Mr. Wes Weaver, President  
Weaver General Construction Co.  
3679 South Huron Street, Suite 404  
Englewood, CO 80110

*Via Email to: wes@weavergc.com  
No Hard Copy to Follow*

Re: Harold D. Thompson Regional Water Reclamation Facility (HDTRWRF)  
Lower Fountain Metropolitan Sewage Disposal District (LFMSDD)

Dear Wes:

Reference is made to your shop submittal identified as follows:

Submittal No.:	03300-005
Date of Submittal:	September 27, 2010
Title:	Fibre Expansion Joint
Specification Section:	03300
Manufacturer:	W. R. Meadows, Inc.

The referenced submittal has been stamped "**No Exception Taken**". No additional information or resubmittal is required on this item. Our comments are as follows:

1. Please note that use of this project will normally also require the use of the SNAP-CAP® product from the same manufacturer. Please provide a submittal confirming the availability and proposed use of that or a similar or equal product.

Please call if you should have any questions.

Sincerely,

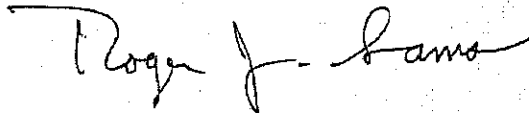

Roger J. Sams, P.E.

RJS/kmw

cc (letter only):

Mr. Jim Heckman, Manager, LFMSDD, [jfmanager@lfmsdd.org](mailto:jfmanager@lfmsdd.org)  
Mr. Jerry Miller, Resident Project Representative, GMS, Inc.  
Ms. Leslie Brown, Weaver General Construction Co., [leslie@weavergc.com](mailto:leslie@weavergc.com)



**GMS, INC.**  
CONSULTING ENGINEERS  
811 NORTH WEBER, SUITE 300  
COLORADO SPRINGS, COLORADO 80903-1074

TELEPHONE (719) 475-2935  
TELEFAX (719) 475-2938

EDWARD D. MEYER, P.E.  
ROGER J. SAMS, P.E.  
GREGORY R. WORDEN, P.E.  
THOMAS A. McCLERNAN, P.E.

KEN L. WHITE, P.L.S.  
DAVID R. FRISCH, P.L.S.  
MARK A. MORTON, P.E.  
JASON D. MEYER, P.E.

June 23, 2011

Mr. Wes Weaver, President  
Weaver General Construction Co.  
3679 South Huron Street, Suite 404  
Englewood, CO 80110

*Via Email to: wes@weavergc.com  
No Hard Copy to Follow*

Re: Harold D. Thompson Regional Water Reclamation Facility (HDTRWRF)  
Lower Fountain Metropolitan Sewage Disposal District (LFMSDD)

Dear Wes:

Reference is made to your shop submittal identified as follows:

Submittal No.:	03300-008.B
Date of Submittal:	June 23, 2011
Title:	Grout for Tie Holes in Digester and Aeration Basins
Specification Section:	03600 Grout
Manufacturer:	The Euclid Chemical Company

The referenced submittal has been stamped "**No Exception Taken**". No additional information or resubmittal is required on this item except as noted below. Our comments are as follows:

1. We take no exception to the use of the Verticoat Supreme product.
2. Please ensure the preparation, use and application of this product, as proposed, is completed in strict accordance with all manufacturer's recommendations and requirements, particularly the surface preparation.

Please call if you should have any questions.

Sincerely,

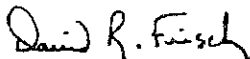

David R. Frisch, P.L.S.

ec (letter only):

Mr. Jim Heckman, Manager, LFMSDD, [lfmanager@lfmsdd.org](mailto:lfmanager@lfmsdd.org)  
Ms. Cindy Murray, Office Manager, Fountain Sanitation District, [fsdistrict@qwestoffice.net](mailto:fsdistrict@qwestoffice.net)  
Mr. Jeff Burst, Project Superintendent, Weaver General Construction Co., [jeff@weavergc.com](mailto:jeff@weavergc.com)  
Mr. John Jacob, Project Manager, Weaver General Construction Co., [john@weavergc.com](mailto:john@weavergc.com)  
Ms. Leslie Brown, Weaver General Construction Co., [leslie@weavergc.com](mailto:leslie@weavergc.com)  
Mr. Mark A. Morton, P.E., GMS, Inc. [mamorton@gmsengr.com](mailto:mamorton@gmsengr.com)

cc: Mr. Jerry Miller, Resident Project Representative, GMS, Inc.

**GMS, INC.**  
CONSULTING ENGINEERS  
611 NORTH WEBER, SUITE 300  
COLORADO SPRINGS, COLORADO 80903-1074

TELEPHONE (719) 475-2935  
TELEFAX (719) 475-2938

EDWARD D. MEYER, P.E.  
ROGER J. SAMS, P.E.  
GREGORY R. WORDEN, P.E.  
THOMAS A. McCLERNAN, P.E.

KEN L. WHITE, P.L.S.  
DAVID R. FRISCH, P.L.S.  
MARK A. MORTON, P.E.  
JASON D. MEYER, P.E.

January 12, 2011

Mr. Wes Weaver, President  
Weaver General Construction Co.  
3679 South Huron Street, Suite 404  
Englewood, CO 80110

*Via Email to: wes@weavergc.com  
No Hard Copy to Follow*

Re: Harold D. Thompson Regional Water Reclamation Facility (HDTRWRF)  
Lower Fountain Metropolitan Sewage Disposal District (LFMSDD)

Dear Wes:

Reference is made to your shop submittal identified as follows:

Submittal No.:	03300-009B
Date of Submittal:	January 12, 2011
Title:	Cast-In-Place Concrete for Digesters/A-Basins, Drilled Caisson Concrete Mix Only
Specification Section:	03300
Manufacturers:	Rocky Mountain Premix; BASF Construction Chemicals, LLC

The referenced submittal has been stamped "**No Exception Taken**". No additional information or resubmittal is required for the drilled caisson concrete mix design included in this Submittal No. 03300-009B. This Submittal No. 03300-009B pertains only to the drilled caisson concrete mix design, Mix Design No. A65FDP, for the aeration basins and aerobic digester basins. It does not include any resubmittal information for the walls, footings and general use concrete mix design, Mix Design No. A70F, of the structures. Information on Mix Design No. A70F is provided in Submittal No. 03300-009C.

Please call if you should have any questions.

Sincerely,



Mark A. Morton, P.E.

MAM/kmw

cc (letter only except as noted):

Mr. Jim Heckman, Manager, LFMSDD, [lfmanager@lfmsdd.org](mailto:lfmanager@lfmsdd.org)  
Ms. Cindy Murray, Office Manager, Fountain Sanitation District, [fsdistrict@qwestoffice.net](mailto:fsdistrict@qwestoffice.net)  
Mr. Jeff Burst, Project Superintendent, Weaver General Construction Co., [jeff@weavergc.com](mailto:jeff@weavergc.com)  
Ms. Leslie Brown, Weaver General Construction Co., [leslie@weavergc.com](mailto:leslie@weavergc.com)  
Mr. Jerry Miller, Resident Project Representative, GMS, Inc. (w/attachments)

**GMS, INC.**  
CONSULTING ENGINEERS  
611 NORTH WEBER, SUITE 300  
COLORADO SPRINGS, COLORADO 80903-1074

TELEPHONE (719) 475-2935  
TELEFAX (719) 475-2938

EDWARD D. MEYER, P.E.  
ROGER J. SAMS, P.E.  
GREGORY R. WORDEN, P.E.  
THOMAS A. McCLERNAN, P.E.

KEN L. WHITE, P.L.S.  
DAVID R. FRISCH, P.L.S.  
MARK A. MORTON, P.E.  
JASON D. MEYER, P.E.

August 23, 2011

Mr. Wes Weaver, President  
Weaver Construction Management, Inc.  
3679 South Huron Street, Suite 404  
Englewood, CO 80110

*Via Email to: wes@weavergc.com  
No Hard Copy to Follow*

Re: Harold D. Thompson Regional Water Reclamation Facility (HDTRWRF)  
Lower Fountain Metropolitan Sewage Disposal District (LFMSDD)

Dear Wes:

Reference is made to your shop submittal identified as follows:

Submittal No.:	03300-009H
Date of Submittal:	July 26, 2011
Title:	Concrete Mix Designs for Headworks Building
Specification Section:	03300
Manufacturer:	Rocky Mountain Premix; BASF Construction Chemicals, LLC

The referenced submittal has been stamped "**No Exception Taken WITH COMMENTS**". No additional information or resubmittal is required on this item. Our comments are as follows:

1. This submittal is a resubmittal with additional information for use of this concrete mix design in all portions of the Headworks Building, particularly all process-related walls at flow channels, and channel slabs. If the intended use in accordance with this resubmittal is not correctly stated, please inform GMS, Inc.
2. It has not clearly been stated that this mix design, Mix Design No. A70F, is intended for use on the non-process related floor slabs. Lacking that request, it is requested that a mix design with a maximum slump of 3 inches and a water/cement ratio no greater than 0.40 be utilized on all floor slabs in this facility. The non-process related floor slabs, i.e., screen room, future chemical feed area and dumpster room, require concrete material of the highest possible durability.
3. It is understood and agreed with Weaver Construction Management, Inc. (WCMI) that this submittal is accepted with comments as an accommodation to facilitate constructability in this structure. Although Submittal No. 03300-009G indicated this mix design was only acceptable in the headworks pump room walls, it is being accepted as described above. This is based on material submitted by WCMI in support of a request to determine that this particular mix design has suitable durability for this applied use. Representations by WCMI have been made that indicate this mix is suitable for the specified use in the HDTRWRF headworks facility.

Mr. Wes Weaver  
August 23, 2011  
Page 2

4. Representations made in the supporting documentation provided by WCMI indicate that durability is largely dependent upon water/cement ratio. Because of the severe environmental conditions in this structure, i.e., corrosive conditions, it is absolutely imperative that the water/cement ratio be maintained as low as reasonably practical, no greater than 0.40. Should it be determined that a mix delivered to the site with a water/cement ratio greater than 0.40, it must be rejected by WCMI.
5. The submitted alternate Mix Design No. A70F indicates a maximum slump of 5" at the point of placement. This is an absolute maximum allowable for this mix design, no exceptions. It shall be the responsibility of the Contractor and his subcontractors and/or suppliers to ensure this slump and other mix design parameters of the project specifications are met at the point of placement in the formwork. Close coordination will be required to ensure that the concrete is batched, transported and placed appropriately to obtain the required product parameters at the point of placement.

Please call if you should have any questions.

Sincerely,

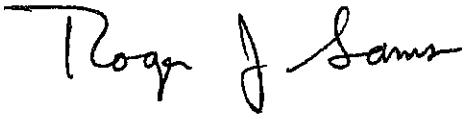

Roger J. Sams, P.E.

RJS/kmw

ec (letter only):

Mr. Jim Heckman, Manager, LFMSDD, [lfmanager@lfmsdd.org](mailto:lfmanager@lfmsdd.org)

Ms. Cindy Murray, Office Manager, Fountain Sanitation District, [fsdistrict@qwestoffice.net](mailto:fsdistrict@qwestoffice.net)

Mr. Jeff Burst, Project Superintendent, Weaver General Construction Co., [jeff@weavergc.com](mailto:jeff@weavergc.com)

Mr. John Jacob, Project Manager, Weaver General Construction Co., [john@weavergc.com](mailto:john@weavergc.com)

Ms. Leslie Brown, Weaver General Construction Co., [leslie@weavergc.com](mailto:leslie@weavergc.com)

Mr. Mike Gaines, P.E., MGA Structural Engineers, [mg@mgase.com](mailto:mg@mgase.com)

cc (letter only):

Mr. Jerry Miller, Resident Project Representative, GMS, Inc.

**GMS, INC.**  
CONSULTING ENGINEERS  
611 NORTH WEBER, SUITE 300  
COLORADO SPRINGS, COLORADO 80903-1074

TELEPHONE (719) 475-2935  
TELEFAX (719) 475-2938

EDWARD D. MEYER, P.E.  
ROGER J. SAMS, P.E.  
GREGORY R. WORDEN, P.E.  
THOMAS A. McCLENNAN, P.E.

KEN L. WHITE, P.L.S.  
DAVID R. FRISCH, P.L.S.  
MARK A. MORTON, P.E.  
JASON D. MEYER, P.E.

July 14, 2011

Mr. Wes Weaver, President  
Weaver General Construction Co.  
3679 South Huron Street, Suite 404  
Englewood, CO 80110

*Via Email to: wes@weavergc.com  
No Hard Copy to Follow*

Re: Harold D. Thompson Regional Water Reclamation Facility (HDTRWRF)  
Lower Fountain Metropolitan Sewage Disposal District (LFMSDD)

Dear Wes:

Reference is made to your shop submittal identified as follows:

Submittal No.:	03300-016
Date of Submittal:	July 11, 2011
Title:	PVC Waterstop for Headworks Building
Specification Section:	03300
Manufacturer:	Bometals, Inc.

The referenced submittal has been stamped "**No Exception Taken**". No additional information or resubmittal is required on this item. Our comments are as follows:

1. We take no exception to the ribbed, center bulb waterstop style submitted. However, in those areas where the clear distance between the face of concrete and the reinforcing steel is less than 4½ inches, i.e., one-half of the length of the waterstop, the submitted 9-inch length waterstop may require modification to accommodate construction conditions. The Contractor has the option of using a 6-inch long waterstop in the same ribbed, center bulb style in such areas in order to minimize the trimming, notching or other modifications required to accommodate construction conditions.

Please call if you should have any questions.

Sincerely,

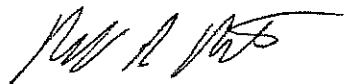

Mark A. Morton, P.E.

MAM/kmw

ec (letter only):

Mr. Jim Heckman, Manager, LFMSDD, [lfmanager@lfmsdd.org](mailto:lfmanager@lfmsdd.org)  
Ms. Cindy Murray, Office Manager, Fountain Sanitation District, [fsdistrict@fsd901.org](mailto:fsdistrict@fsd901.org)  
Mr. Jeff Burst, Project Superintendent, Weaver General Construction Co., [jeff@weavergc.com](mailto:jeff@weavergc.com)  
Mr. John Jacob, Project Manager, Weaver General Construction Co., [john@weavergc.com](mailto:john@weavergc.com)  
Ms. Leslie Brown, Weaver General Construction Co., [leslie@weavergc.com](mailto:leslie@weavergc.com)

cc (letter only):

Mr. Jerry Miller, Resident Project Representative, GMS, Inc.

**GMS, INC.**  
CONSULTING ENGINEERS  
611 NORTH WEBER, SUITE 300  
COLORADO SPRINGS, COLORADO 80903-1074

TELEPHONE (719) 475-2935  
TELEFAX (719) 475-2938

EDWARD D. MEYER, P.E.  
ROGER J. SAMS, P.E.  
GREGORY R. WORDEN, P.E.  
THOMAS A. McCLERNAN, P.E.

KEN L. WHITE, P.L.S.  
DAVID R. FRISCH, P.L.S.  
MARK A. MORTON, P.E.  
JASON D. MEYER, P.E.

July 25, 2011

Mr. Wes Weaver, President  
Weaver Construction Management, Inc.  
3679 South Huron Street, Suite 404  
Englewood, CO 80110

*Via Email to: wes@weavergc.com  
No Hard Copy to Follow*

Re: Harold D. Thompson Regional Water Reclamation Facility (HDTRWRF)  
Lower Fountain Metropolitan Sewage Disposal District (LFMSDD)

Dear Wes:

Reference is made to your shop submittal identified as follows:

Submittal No.:	03600-002A
Date of Submittal:	July 22, 2011
Title:	Injectable Grout
Specification Section:	03600 Grout
Manufacturer:	Green Mountain International, LLC

The referenced submittal has been stamped "**No Exception Taken**" except as stated below. No additional information or resubmittal is required on this item. Our comments are as follows:

1. If a crack is found to be greater than  $1/16^{th}$  inch or greater in width, we request the Contractor and/or their subcontractor contact us to discuss the crack sealing procedure that will be implemented prior to the work being accomplished.

Please call if you should have any questions.

Sincerely,

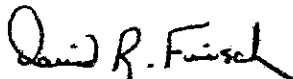

David R. Frisch, P.L.S.

DRF/lme

ec (letter only):

Mr. Jim Heckman, Manager, LFMSDD, [lfmanager@lfmsdd.org](mailto:lfmanager@lfmsdd.org)  
Ms. Cindy Murray, Office Manager, Fountain Sanitation District, [fsdistrict@fsd901.org](mailto:fsdistrict@fsd901.org)  
Mr. Jeff Burst, Project Supt., Weaver Construction Management, Inc., [jeff@weavergc.com](mailto:jeff@weavergc.com)  
Mr. John Jacob, Project Mgr., Weaver Construction Management, Inc., [john@weavergc.com](mailto:john@weavergc.com)  
Ms. Leslie Brown, Weaver Construction Management, Inc., [leslie@weavergc.com](mailto:leslie@weavergc.com)

cc (letter only):

Mr. Jerry Miller, Resident Project Representative, GMS, Inc.

**REQUEST FOR INFORMATION**

Request for Information -	18	ROUTING	DATE SENT	VIA MAIL, EMAIL OR FAX			DATE RECEIVED	VIA MAIL, EMAIL OR FAX		
				M	E	F		M	E	F
OWNER: LFMSDD		Contractor to Engineer	8/11/2011		X		8/11/2011		X	
PROJECT: HDTRWRF		Engineer to Contractor	8/12/2011		X					
ENGINEER: GMS, Inc.		Copy to Owner	8/12/2011		X				X	

CONTRACTOR: Weaver General Construction Co.

RFI TITLE: Water stop detail and mat'l

REFERENCE: A-HW6

**CONTRACTOR'S REQUEST**

The following information, interpretation, or clarification is requested as described below or in the attachments.

BCCI requests to use Sika Swell in lieu of the PVC water stop in the attached location. Product data is also attached.

By: Jeff Burst

Date: 8/11/2011

**ENGINEER'S RESPONSE**

The following information, interpretation, or clarification is provided as described below or in the attachments.

GMS, Inc. has reviewed this request and consulted with MGA Structural Engineers, Inc., the structural engineer of record for this project. We cannot accept the use of the submitted product, Sika Swell, in lieu of the PVC waterstop, split and inserted around the vertical bars in the subject joint at the headworks channels. To facilitate the installation, function and performance of the PVC waterstop, we will allow a reduction in the depth of the key for the slab-wall joint from 1.5" to 1.0". This will permit greater embedment of the waterstop beyond the limit of the key. In addition, we would consider the use of a split waterstop with one side of the split section being embedded into the wall and the other side either removed or embedded in the slab with the solid side of the stop. This will permit greater flexibility of the stop material notched and placed around the vertical bars in the wall.

By: Roger J. Sams

Date: August 12, 2011

cc: Wes Weaver, Jeff Burst, John Jacob, WGCC; Jim Heckman, LFMSDD; Tim Long, Charlie Edgar, Cindy Murray, FSD; Al Testa, CCMD; Roger Sams, Dave Frisch, Jerry Miller, GMS, Inc.; Pat Danenberg, MWI; John Peiffer, Mike Gaines, MGA; Mark Reasinger, PECI

# Request For Information



Project Name Harold Thompson WRF  
Project No. 9921  
Date 9-Aug  
Status Open  
Resolved Date  
Reason for Request Alternate Proposal  
Response Due 16-Aug

RFI No.

*12-6/90-  
WA-47508-10-18*

To Weaver GC  
CC  
From Nick Dewald  
Subject Alternate Waterstop at Chanel Slab  
Drawing No. HW-6, 7, 8, 9  
Detail No. A&C/WH-7, A&C/HW8, A&B/HW-8, A,B,C,D&E/HW-9  
Contractor Ref. No. NA

Concerns  Clarification  Quality  
 Schedule  Cost

### Information Requested

BCCI proposes to use SikaSwell S-2 in leu of 9" or 6" waterstop at the keyed slab joint in the screen, bypass, grit and flume channel due to the interference with the vertical rebar. See attached drawing.

Response

Client Representative \_\_\_\_\_

Date \_\_\_\_\_



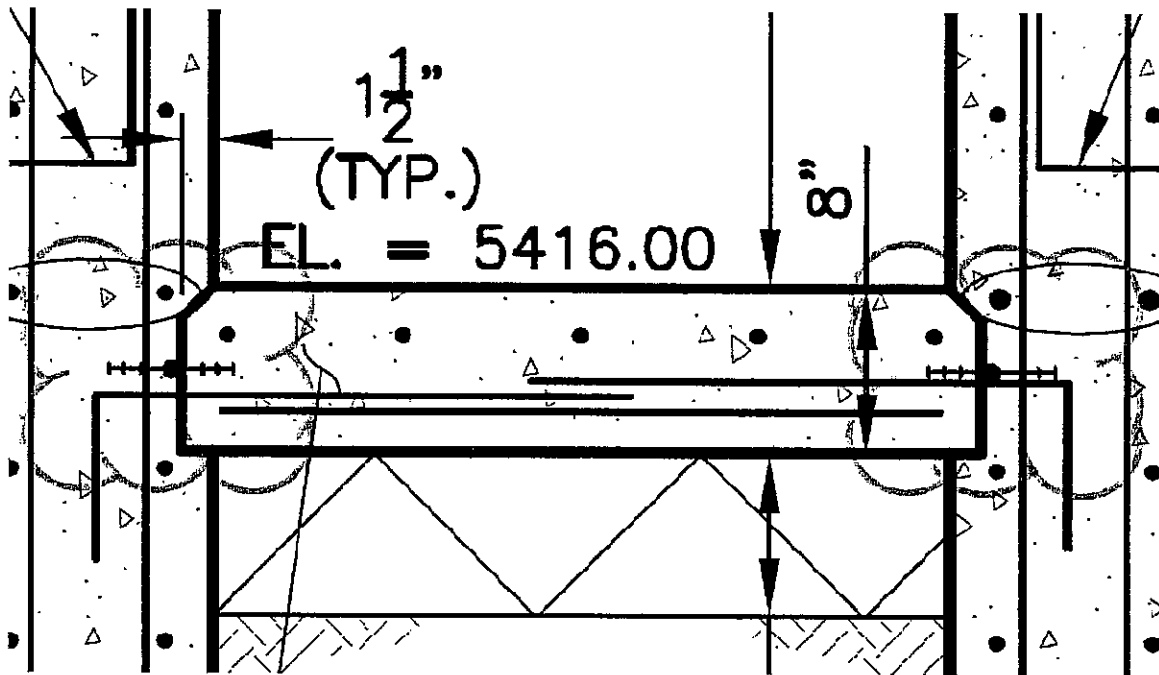

The clouded area above represents the typical interference between waterstop and the vertical mat of steel in the screen, bypass, grit and flume channels. BCCI's proposed solution is to use SikaSwell S-2 in place of the PVC waterstop. The sketch below shows the intended location of the SikaSwell in red.

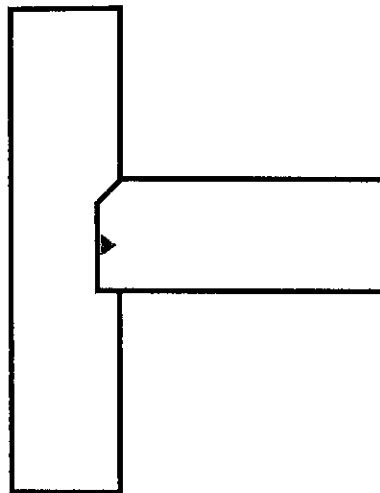

## SikaSwell® S-2

One part polyurethane, extrudable swelling waterstop (bentonite-free)

**Description** SikaSwell S-2 is a specially formulated, high-performance, swellable, one-component, polyurethane-based waterstop for use in all kinds of construction joints. Swelling rubber creates a compression seal within joint, blocking the passage of water.

**Where to Use**

- Designed for construction joints in new watertight concrete structures.
- Excellent for sealing pipe penetrations through walls and floor slabs.
- Excellent for sealing joints between precast elements.
- May be applied to horizontal, vertical and overhead surfaces.
- Ideal for watertight construction joints between new and existing concrete.

**Advantages**

- Swells up to 100% in potable water, slightly less in salt water and wastewater.
- Permanently water resistant, with no leaching and does not dissolve in water.
- Capable of sealing construction joints with head pressures of up to 50 psi (115 ft. head).
- Elastic-withstands wet/dry cycling.
- Easy, simple application.
- Adaptable in the field to suit job requirements.
- No nails, glue, or hooks required.
- Controlled expansion eliminates cracking in fresh concrete.
- Offers resistance to various chemicals.
- Thixotropic properties allow SikaSwell S-2 to seal irregular joint surfaces.
- Very economical.
- Saves labor by eliminating inverted keyways, split forming, heat splicing, special fittings and tying to rebar associated with conventional PVC waterstops.
- No mixing required.
- Allows more thorough vibration of concrete at joint, resulting in better concrete consolidation which aids in achieving a watertight joint.

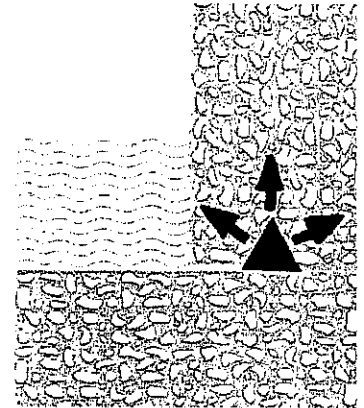

### Typical Data (Material and curing conditions 73°F (23°C) and 50% R.H.)

<b>Shelf life</b>	9 months	
<b>Storage Conditions</b>	For best results, store dry at 70°F (20°C) before using.	
<b>Color</b>	Red	
<b>Temperature of Product for Best Application</b>	50° to 90°F	
<b>Tack Free Time</b>	2-3 hours	
<b>Shore A Hardness</b>	Swollen (7 days in tap water)	>10
	Non Swollen (7 days)	40-60
<b>Swelling Capacity</b>	1 day	<20%
	7 days	>100%

Reduced and delayed swelling properties in salty water.

### Suggested Cross Section of Extruded Bead

Concrete Thickness	Number of Beads (in.)	Side length of triangular bead (in.)
8-12	1	5/8
12-20	1	3/4
> 20	2	3/4

**Note:** If the maximum size aggregate in the concrete is greater than 1 inch, use 3/4 inch triangular section(s).



<b>Coverage</b>	20 fl.oz. uni-pac sausage seals:
	Triangular                      Yield
	5/8 x 5/8 x 5/8 in.      18 lineal ft.
	3/4 x 3/4 x 3/4 in.      12 lineal ft.
Note: Yield may vary based on substrate irregularities.	
<b>Packaging</b>	Disposable 20 fl. oz., moisture-proof uni-pac sausages, 20/carton.

**How to Use**  
**Surface Preparation**

Clean all surfaces. Substrate must be clean, sound, free of loose particles, dust, laitance, oils, and other contaminants. Surface may be dry or damp, with no presence of standing water. Do not leave the product in contact with wet concrete, or on a surface with a very high moisture content, for a long period of time, before casting new concrete. These conditions will decrease the adhesion between the SikaSwell S-2 bead and the surface of the joint.

**Application**

Recommended application temperatures: 50°-90°F. Extrude material using Sika MK-5 bulk caulking gun or other approved bulk gun. Cut the nozzle to obtain a triangular extrusion section with a size fulfilling effective needs (or use nozzle included in carton of SikaSwell S-2). Apply a uniform, continuous bead to the hardened concrete. Wait for approximately 2 hours after placement of the SikaSwell S-2 before placing concrete. The minimum thickness of concrete around the SikaSwell S-2 should be 4 inches on each side (reinforced concrete) or 6 in. on each side (non-reinforced concrete) and 4 inches on top. For optimum application, store at 70°F for a minimum of 8 hours prior to use; if the material appears stiff, knead the sausage for a short time before placing in bulk gun.

**Limitations**

- Not suitable for expansion joints.
- For critical applications with high water pressure, Sika recommends the use of the SikaSwell Hose waterstop.
- Protect from rain to avoid expansion before placing new concrete and to assure 100% swelling capacity.
- Avoid placement of the concrete from a height greater than 20 inches. If this is not possible, allow SikaSwell S-2 to cure for 2 days before placing concrete.

**Caution**

Avoid skin and eye contact. Use of NIOSH approved organic vapor respirator, safety goggles, and chemical resistant gloves recommended. Remove contaminated clothing and shoes.

**First Aid**

In case of skin contact, wash thoroughly with soap and water. For eye contact, flush immediately with plenty of water for at least 15 minutes; contact a physician. Wash clothing before re-use. Discard contaminated shoes.

**Clean Up**

Uncured material can be removed with approved solvent. Cured material can only be removed mechanically. For spillage, collect and dispose of in accordance with current, applicable local, state, and federal regulations.

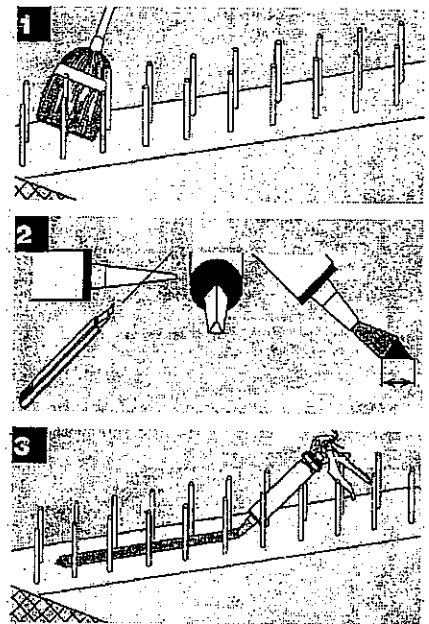

**SikaSwell S-2 Installation**

1. Clean surface of concrete.
2. Cut nozzle to obtain triangular extrusion section (or use nozzle included in carton of SikaSwell S-2).
3. Apply a uniform, continuous bead to hardened concrete. Wait 2 hours before placing new concrete.

**KEEP CONTAINER TIGHTLY CLOSED - KEEP OUT OF REACH OF CHILDREN - NOT FOR INTERNAL CONSUMPTION - FOR INDUSTRIAL USE ONLY**

All information provided by Sika Corporation ("Sika") concerning Sika products, including but not limited to, any recommendations and advice relating to the application and use of Sika products, is given in good faith based on Sika's current experience and knowledge of its products when properly stored, handled and applied under normal conditions in accordance with Sika's instructions. In practice, the differences in materials, substrates, storage and handling conditions, actual site conditions and other factors outside of Sika's control are such that Sika assumes no liability for the provision of such information, advice, recommendations or instructions related to its products, nor shall any legal relationship be created by or arise from the provision of such information, advice, recommendations or instructions related to its products. The user of the Sika product(s) must test the product(s) for suitability for the intended application and purpose before proceeding with the full application of the product(s). Sika reserves the right to change the properties of its products without notice. All sales of Sika product(s) are subject to its current terms and conditions of sale which are available at [www.sikausa.com](http://www.sikausa.com) or by calling 800-933-7452.

Prior to each use of any Sika product, the user must always read and follow the warnings and instructions on the product's most current Technical Data Sheet, product label and Material Safety Data Sheet which are available online at [www.sikausa.com](http://www.sikausa.com) or by calling Sika's Technical Service Department at 800-933-7452. Nothing contained in any Sika materials relieves the user of the obligation to read and follow the warnings and instruction for each Sika product as set forth in the current Technical Data Sheet, product label and Material Safety Data Sheet prior to product use.

**LIMITED WARRANTY:** Sika warrants this product for one year from date of installation to be free from manufacturing defects and to meet the technical properties on the current Technical Data Sheet if used as directed within shelf life. User determines suitability of product for intended use and assumes all risks. Buyer's sole remedy shall be limited to the purchase price or replacement of product exclusive of labor or cost of labor. **NO OTHER WARRANTIES EXPRESS OR IMPLIED SHALL APPLY INCLUDING ANY WARRANTY OF MERCHANTABILITY OR FITNESS FOR A PARTICULAR PURPOSE. SIKASHALL NOT BELIEVE UNDER ANY LEGAL THEORY FOR SPECIAL OR CONSEQUENTIAL DAMAGES. SIKASHALL NOT BE RESPONSIBLE FOR THE USE OF THIS PRODUCT IN A MANNER TO INFRINGE ON ANY PATENT OR ANY OTHER INTELLECTUAL PROPERTY RIGHTS HELD BY OTHERS.**

Visit our website at [www.sikausa.com](http://www.sikausa.com)

1-800-933-SIKA NATIONWIDE

Regional Information and Sales Centers. For the location of your nearest Sika sales office, contact your regional center.

Sika Corporation  
201 Polito Avenue  
Lyndhurst, N.J 07071  
Phone: 800-933-7452  
Fax: 201-933-6225

Sika Canada Inc.  
601 Delmar Avenue  
Pointe Claire  
Quebec H9R 4A9  
Phone: 514-697-2610  
Fax: 514-694-2792

Sika Mexicana S.A. de C.V.  
Carretera Libre Celaya Km. 8.5  
Fracc. Industrial Balvanera  
Corregidora, Queretaro  
C.P. 76920  
Phone: 52 442 2385800  
Fax: 52 442 2250537

Sika and SikaSwell are registered trademarks. Printed in Canada.

